**EFFICIENCY, RELIABILITY AND PERFORMANCE****WASTES / ACIDS
CHEMICALS / PLATING
PHOTOGRAPHIC ETCHING**

- **Flows to 130 GPM or 97 ft. TDH @ 60 Hz**
(483 LPM or 27.3 m @ 50 Hz)
- **Non-metallic solution contact**
Glass reinforced polypropylene or carbon reinforced PVDF
(See a chemical resistance chart)
- **High operating efficiency – up to 70%**
- **Capable of running dry without damage**
- **Powerful rare earth magnets**
Provide sure coupling to 1.8 S.G.
- **Choice of connections – NPT or BSP threads, flanges or unions**
- **Accepts standard motors NEMA or IEC metric**

Series 'FE' magnetic coupled pumps are seal-less and "leak-proof", providing total solution containment. They are available in a choice of two different corrosion resistant materials for a wide range of chemical and temperature compatibility and are ideal for handling even the most difficult applications.

The Series 'FE' magnetic coupled pumps offer extremely high operating efficiencies for their size; up to 70%. This technological advancement results in smaller motor horsepower and means lower energy consumption and operating costs over the long life cycle of the pump.

These pumps utilize powerful rare earth, neodymium, magnets which allow them to operate at full flow with a full size impeller while handling liquids over 1.8 specific gravity.

Additionally the Series 'FE' is capable of running dry without damage when equipped with the standard carbon bushing and under optimum operating conditions. This helps protect the pump from operator errors and system upsets.

Their innovative and highly efficient design, and low energy consumption make these pumps one of the most versatile and economical centrifugal pumps on the market.

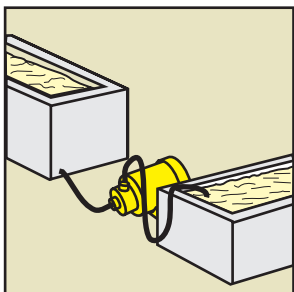
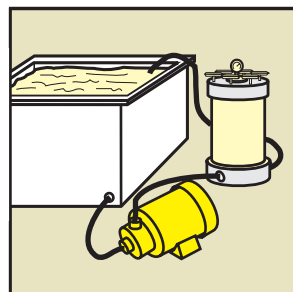
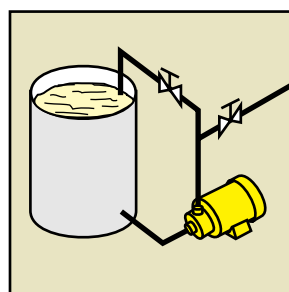
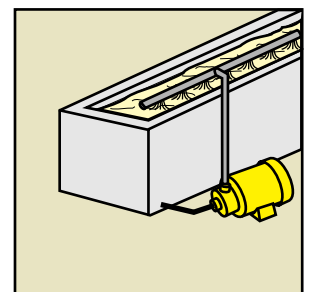
**WASTE TREATMENT****FILTRATION****MIXING and
TRANSFER PUMPING****RECIRCULATION**



SERIES 'FE' | MAGNETIC COUPLED PUMPS

2900 MacArthur Blvd. Northbrook, IL. USA 60062 www.serfilco.com (800) 323 - 5431

Standard models are constructed of glass-fiber reinforced polypropylene or carbon-fiber reinforced PVDF for suction casing, magnet liner and impeller. Impeller magnets are encapsulated in unfilled polypropylene or unfilled PVDF. The front and rear thrust rings and shaft are high purity, fluoride resistant alumina ceramic. The impeller thrust ring

is molybdenum disulfide filled PTFE. The casing 'O' ring is viton. Maximum pump pressure; 90 PSI (6.2 bar).

Motors are continuous-duty and have a 1.5 service factor. Single phase motors are supplied with 8 ft. (2.4m) of 3-wire cord and plug. Three phase motors are not supplied with cord.

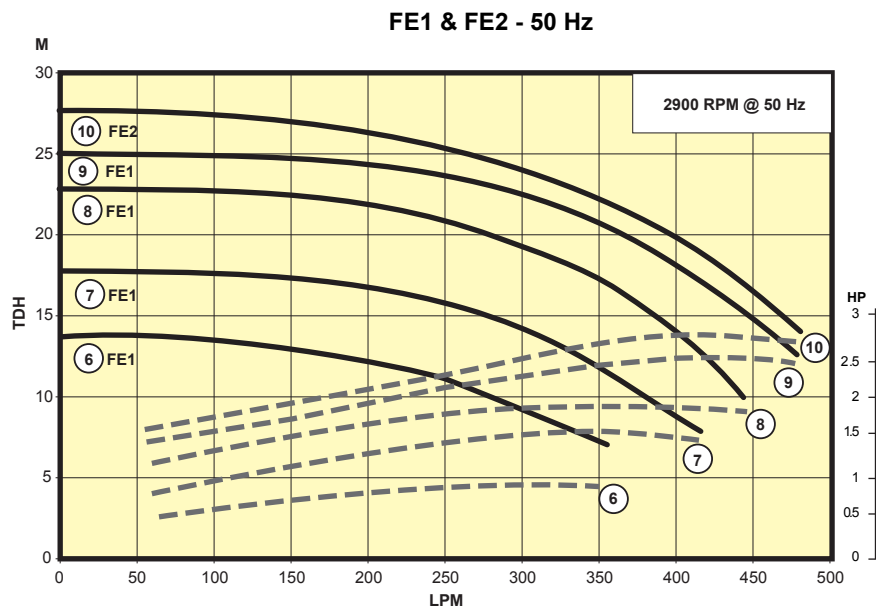
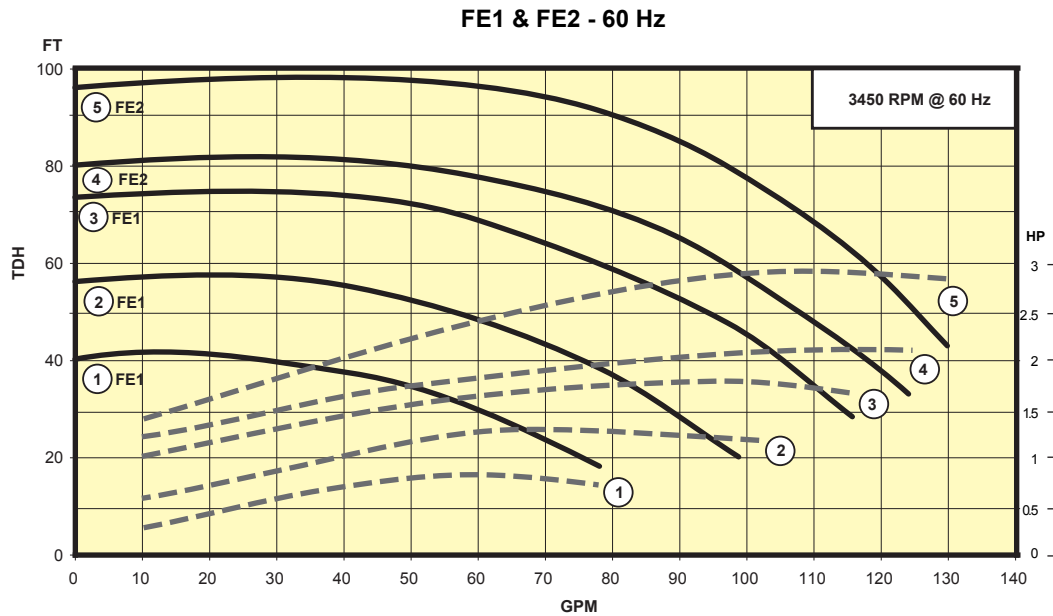



SERIES 'FE' | MAGNETIC COUPLED PUMPS

2900 MacArthur Blvd. Northbrook, IL. USA 60062 www.serfilco.com (800) 323 - 5431

For standard 60HZ pump-motor combination, select model from TABLE I
For custom pump-motor combination, select from components in TABLE II

TABLE I

Select pump-motor model or flow curve number providing the desired performance

MODEL FE1

FLOW CURVE	POLYPROPYLENE PUMP / MOTOR		PVDF PUMP / MOTOR		* Motor HP shown will handle full flow to a S.G. of:
	MODEL NUMBER	PRICE CODE NUMBER	MODEL NUMBER	PRICE CODE NUMBER	
1	FE1MPVGC 1A-D1.0	51-0211-G	FE1MKVGC 1A-D1.0	51-0311-G	1.35
2	FE1MPVGC 2A-D1.5	51-0221-J	FE1MKVGC 2A-D1.5	51-0321-J	1.23
3	FE1MPVGC 3B-D2.0	51-0232-K	FE1MKVGC 3B-D2.0	51-0332-K	1.14

MODEL FE2

4	FE2MPVGC 4C-D3.0	51-0443-L	FE2MKVGC 4C-D3.0	51-0543-L	1.45
5	FE2MPVGC 5C-D5.0	51-0454-P	FE2MKVGC 5C-D5.0	51-0554-P	1.75

* For higher specific gravity or reduced flow, refer to HP required. Then refer to Table II and construct Model and Price Code Number accordingly

TABLE II

To determine pump-motor for a specific flow, TDH, and/or specific gravity, select flow/pressure point on performance curve (solid line). Required HP is determined by moving vertically to corresponding HP

curve (dotted line) and then horizontally to HP scale. Multiply indicated HP by specific gravity of fluid to be pumped. Select pump materials and construct Model and Price Code.

EXAMPLE: PUMP + IMPELLER + MAGNET/FRAME + MOTOR = PRICE CODE NO.
 FE1MPVGC + 3 + B + -D2.0 = 51-0232-K

PUMP¹

MODEL NUMBER	PCN
FE1 MPVGC Polypropylene	51-02
FE1 MKVGC PVDF	51-03
FE2 MPVGC Polypropylene	51-04
FE2 MKVGC PVDF	51-05

IMPELLER

	MODEL	FLOW CURVE	ADD TO	
			MODEL	PCN
60 HZ	FE1	1	1	1
		2	2	2
		3	3	3
	FE2	4	4	4
		5	5	5
50 HZ	FE1	6	6	6
		7	7	7
		8	8	8
	FE2	9	9	9
		10	10	0

¹ For pump only eliminate motor suffix from price code number.

² single phase —
 115-208-230V/1/60 or
 110-220V/1/50
 Three phase —
 208-230-460V/3/60 or
 220-380V/3/50

MAGNET SET / FRAME SIZE					MOTOR ²				
	HP/KW	MAGNET SET	FRAME SIZE	ADD TO		SINGLE PHASE		THREE PHASE	
				MODEL	PCN	MODEL	PCN	MODEL	PCN
60 HZ	.75	6 POLE	56C	A	1	-C.75	-A	-D.75	-E
	1.0	6 POLE	56C	A	1	-C1.0	-C	-D1.0	-G
	1.5	6 POLE	56C	A	1	-C1.5	-D	-D1.5	-J
	2.0	6 POLE	143/5 TC	B	2	—	—	-D2.0	-K
	3.0	8 POLE	143/5 TC	C	3	—	—	-D3.0	-L
	5.0	10 POLE	182/4 TC	D	4	—	—	-D5.0	-P

50 HZ	1.0	6 POLE	56C	A	1	-C1.0-50	-A	-D1.0-50	-D
	1.5	6 POLE	56C	A	1	-C1.5-50	-C	—	—
	1.5	6 POLE	143/5 TC	B	2	—	—	-D1.5-50	-E
	2.0	6 POLE	143/5 TC	B	2	—	—	-D2.0-50	-G
	3.0	8 POLE	182/4 TC	E	5	—	—	-D3.0-50	-J
	5.0	10 POLE	182/4 TC	H	7	—	—	-D5.0-50	-K
	1.0/.75	6 POLE	80 FR	C	3	—	—	-DM.75	-L
	1.5/1.1	6 POLE	80 FR	C	3	—	—	-DM1.1	-P
	2.0/1.5	6 POLE	90 FR	D	4	—	—	-DM1.5	-Q
	3.0/2.2	8 POLE	90 FR	F	6	—	—	-DM2.2	-U
	4.0/3.0	10 POLE	100 FR	J	8	—	—	-DM3.2	-V
5.5/4.0	10 POLE	112 FR	M	9	—	—	-DM4.2	-W	



2900 MacArthur Blvd. Northbrook, IL. USA 60062 www.serfilco.com (800) 323 - 5431

OPTIONAL, use Price Code Number

DESCRIPTION	ADD OR CHANGE MODEL	ADD TO PCN
O-RING: (Change V in Model)		
EPDM	-L	-1
Gylon gasket	-G	-2
Simriz	-Z	-3
Kalrez	-K	-4
Bushing: (Change C in Model)		
Teflon	-T	-T
Alumina Ceramic	-R	-R

DESCRIPTION	ADD OR CHANGE MODEL	ADD TO PCN
CONNECTIONS:		
BSP threads	-B	-B
Union	-U	-U
Flange	-F	-F
SPECIALS:		
SiC (bushing, thrust ring, shaft)	-S	-S
Hastelloy shaft	-H	-H
Titanium hardware	-M	-M
Non-Sparking ring	-N	-N
EXP MOTOR		
Also requires Non-Sparking ring	-X-N	-XN

DIMENSIONS

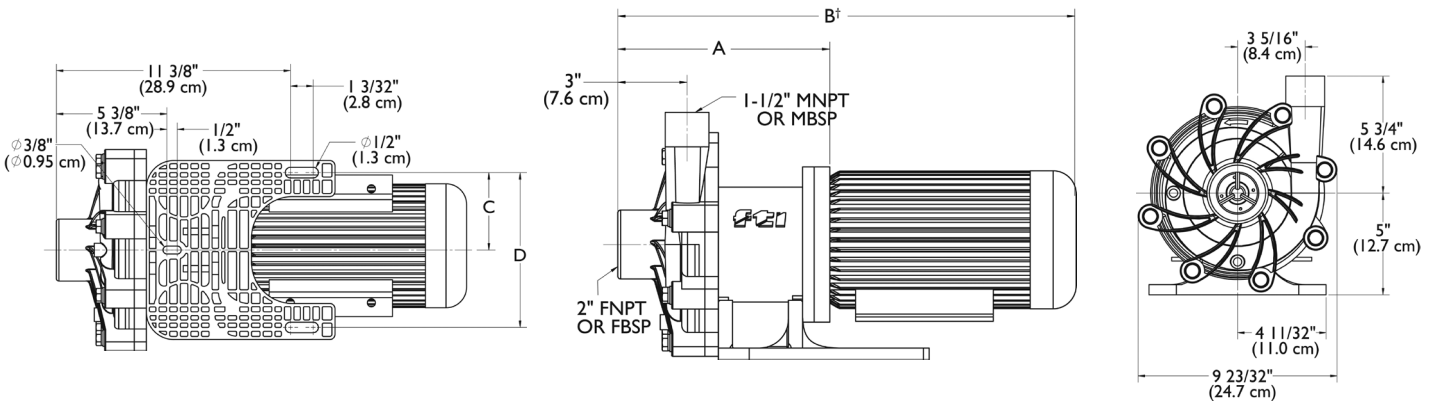

MOTOR FRAME	A	B	C	D	Weight - lbs (kg)	
					PP	PVDF
NEMA 56C	8-17/32" (21.7cm)	20-17/32" (52.1cm)	3-3/4" (9.5 cm)	7-1/2" (19.1 cm)	21.6 (9.8)	22.8 (10.3)
NEMA 145	8-17/32" (21.7cm)	18-29/32" (48.0cm)	3-3/4" (9.5 cm)	7-1/2" (19.1 cm)	21.6 (9.8)	22.8 (10.3)
NEMA 184	9-13/32" (23.9cm)	22-6/32 (56.4 cm)	3-3/4" (9.5 cm)	7-1/2" (19.1 cm)	25.7 (11.7)	26.9 (12.2)
IEC 80/90 w/B14 or B5*	9-5/32" (23.3 cm)	19-11/16" (50.0 cm)	3-3/4" (9.5 cm)	7-1/2" (19.1 cm)	22.1 (10)	23.3 (10.6)
IEC 80/90 w/B14 ATEX*	9-5/32" (23.3 cm)	19-7/8" (50.5 cm)	3-3/4" (9.5 cm)	7-1/2" (19.1 cm)	N/A	23.5 (10.7)
IEC 100 w/B14 or B5*	9-7/32" (23.4 cm)	21-3/8" (54.3 cm)	3-5/32" (8.0 cm)	6-10/32" (16.0 cm)	25.2 (11.4)	26.4 (12)
IEC 100 w/B14 ATEX*	9-7/32" (23.4 cm)	21-3/8" (54.3 cm)	3-5/32" (8.0 cm)	6-10/32" (16.0 cm)	N/A	26.6 (12.1)
IEC 112 w/B14 or B5*	9-7/32" (23.4 cm)	21-7/8" (55.6 cm)	3-3/4" (9.5 cm)	7-1/2" (19.1 cm)	25.2 (11.4)	26.4 (12)
IEC 112 w/B14 ATEX*	9-7/32" (23.4 cm)	21-7/8" (55.6 cm)	3-3/4" (9.5 cm)	7-1/2" (19.1 cm)	N/A	26.6 (12.1)